



**HEALTH MATE**

# Serenity Series

Owner's manual



Operating instructions for your  
Health Mate® full spectrum sauna



## Guidelines and Helpful Tips

Congratulations on your purchase of your Health Mate® Sauna.  
We are confident that you will enjoy the many benefits for years to come.

Carefully read this manual before using your Health Mate® Sauna for the first time. We recommend keeping this manual for review and future reference.



# Health Mate®

## The leader of infrared wellness since 1979

Welcome to the Health Mate® Family!

As the leading creator of infrared sauna wellness for more than 45 years, Health Mate® Infrared Sauna continues to provide excellent craftsmanship and innovative technology; hand selected from 100% Mahogany, and crafted from nature to nurture.

We attribute this growth and success entirely to our customer satisfaction, the recognized health benefits, and the quality of our superior craftsmanship. At Health Mate®, we use only the finest materials combined with state-of-the-art construction and the highest safety standards in the industry.

Within the family of Health Mate collections, enjoy such features as our patented and lifetime-warrantied TECOLOY™ infrared heaters, responsibly sourced wood, LED color lighting, Bluetooth® compatible audio components, and additional characteristics designed to treat the needs of one's lifestyle and wellness.

We are so happy to have you join us and look forward to sharing in your experience as you revitalize with the difference Health Mate® provides: a difference in benefits, quality, and attitude as we support you along your journey through health and wellness!

Happy healing to you and your new mate,

Your Health Mate® Family



# TABLE OF CONTENTS

INSTALLATION AND MAINTENANCE.....	4
CONTROL PANEL.....	14
GETTING STARTED.....	16
HELPFUL TIPS FOR ENJOYING YOUR SAUNA SESSIONS.....	23
SAFETY PRECAUTIONS FOR YOUR HEALTH MATE SAUNA.....	26
TROUBLESHOOTING GUIDE.....	28
OPTIONAL ACCESSORIES.....	31
LIMITED WARRANTY.....	32

The information contained in this manual is subject to change without notice



# INSTALLATION & MAINTENANCE

## Choosing a location

In determining a location for your Health Mate Infrared Sauna, there are two important things to keep in mind: First, the sauna should always be placed on a level surface. Second, the sauna must be placed in a dry area.

The installation requirements for your Health Mate Infrared Sauna are as follows:

1. Your Health Mate cabin is intended to be a self-contained and freestanding unit. It must not be built into to any structure.
2. There should be a minimum of 5-inches / 12,5 cm clearance from the wall on all sides of the unit to allow easy access to the main power cord.

Moisture may cause damages to the interior and exterior of the sauna. Basement, attic, garage, playroom, spare bedroom, new extension and garden chalet are just a few of possible locations for your sauna. Health Mate's beautiful and simple mahogany wooden exterior will compliment the interior of your house beautifully.

## Cleaning & maintenance

Before using your Health Mate Infrared Sauna for the first time, clean the inside of the sauna with a damp cloth. When cleaning the exterior, use a natural furniture polish.

We recommend turning the sauna on for the maximum time and temperature in order to burn off any factory dust prior to using the sauna for the first time. For maximum heater performance please cycle your Health Mate (turn on to max temperature and run for one hour), 2-3 times.

Scratches and stains on the inside of the sauna can be removed by simply using a fine grade sandpaper over the damaged area.



# INSTALLATION & MAINTENANCE

## **Choosing a location**

Assembly of the sauna requires 2-3 adults depending on model to complete. Please watch video thoroughly before and during assembly to ensure proper installation of the unit.

If you encounter any problems or have questions during the assembly, please feel free to call for Technical Support: (714)739-6600



**HEALTH MATE**

# ASSEMBLY & WIRING GUIDE SERENITY SERIES

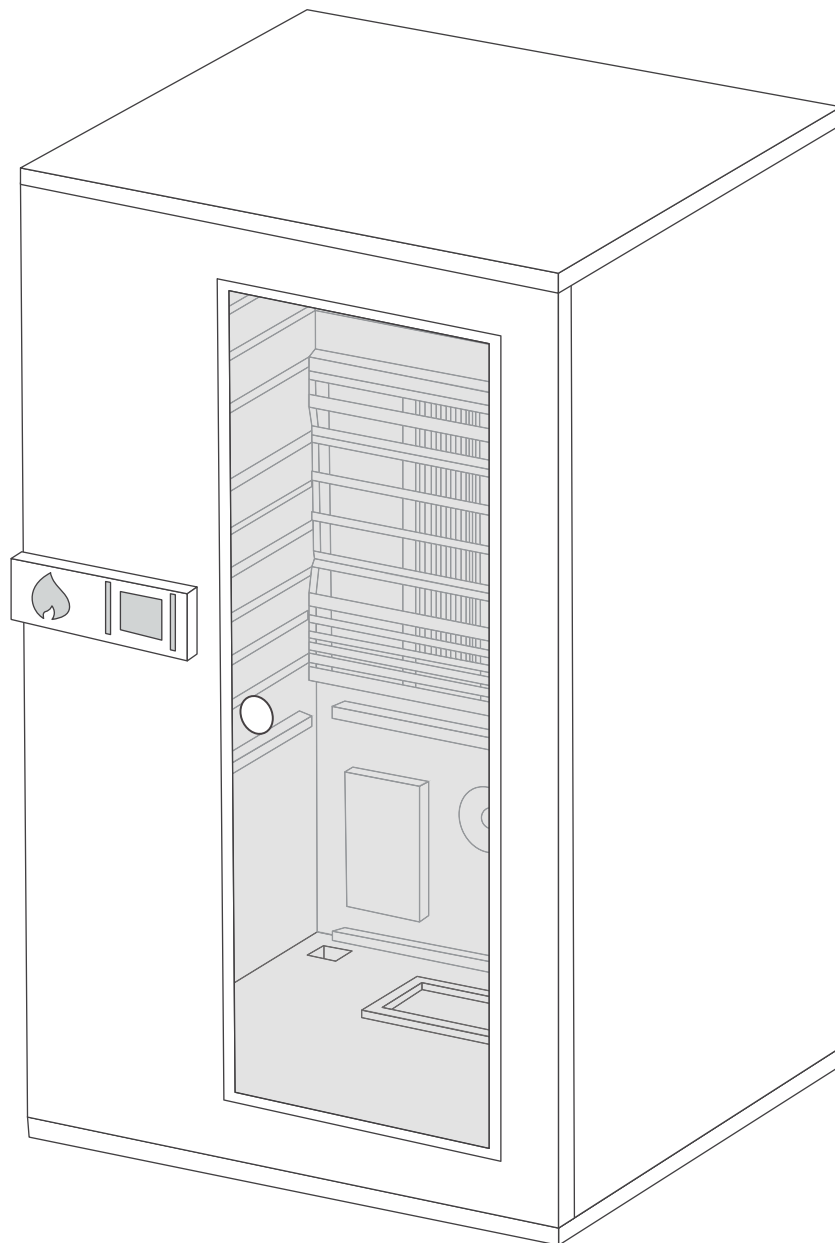



## 1. INSTALL THE FEET IF NEEDED

Watch the assembly video here:  
[www.healthmatesauna.com/faq/how-do-i-assemble-my-infrared-sauna/](http://www.healthmatesauna.com/faq/how-do-i-assemble-my-infrared-sauna/)

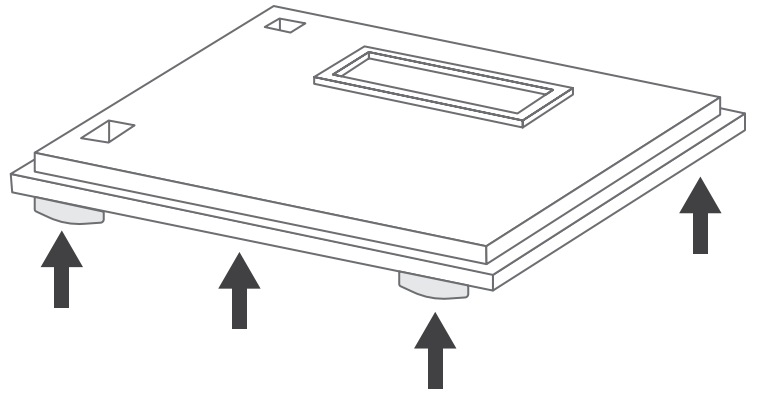

## 2. INSTALL THE WALLS

Magnet System

Our innovative magnet system makes assembly easier than ever. Simply align the panels and let the magnets securely connect — no tools required.



Watch the assembly video here:  
<https://tinyurl.com/MagnetTypeHMS>

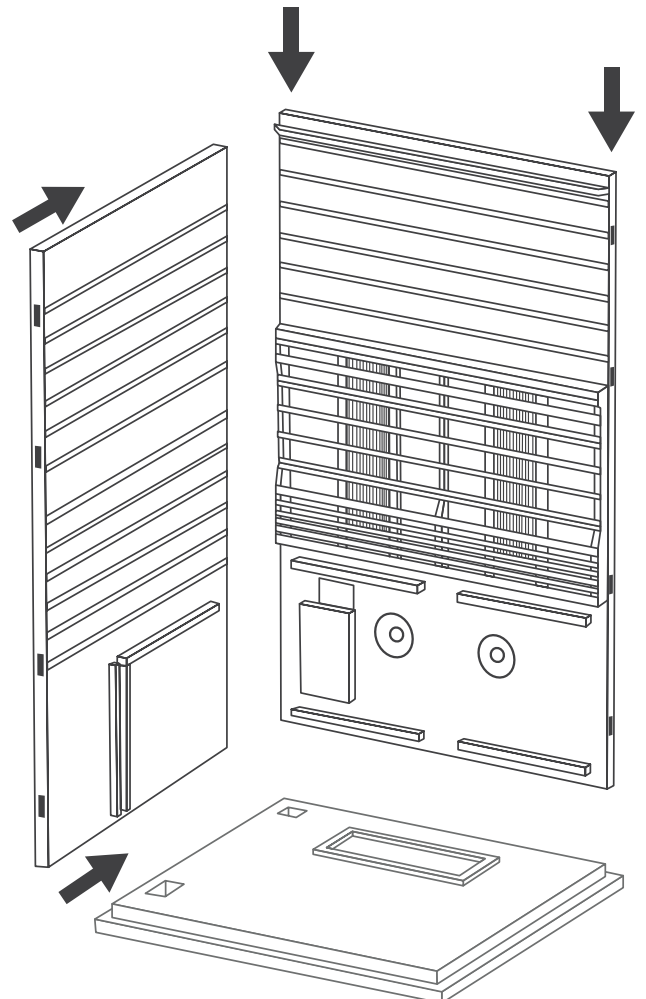



### 3. SAUNA MAIN POWER SUPPLY PLUG IN

- Connect the outside power plug (marked 0 on the picture) to the wall mount outlet directly.
- Connect the outside power plug (marked 1 on the picture) to the power supply.
- Couple the USB audio and the controller (marked 4 & 5 on the picture) connectors to the power supply.
- Connect the unlabeled floor heater power plug (marked 2 on the picture) to the bench support. (See step 6" Inside the bench wiring")
- The back wall heater 13 should already be connected to the power supply.

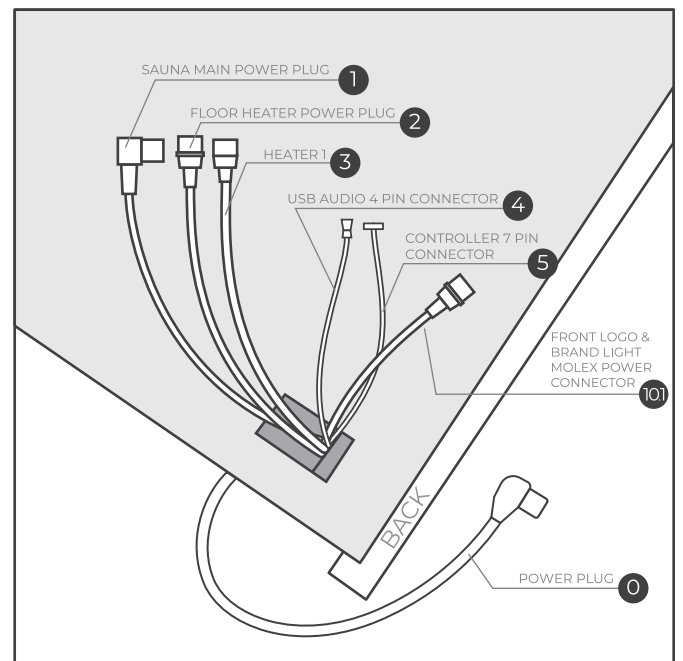
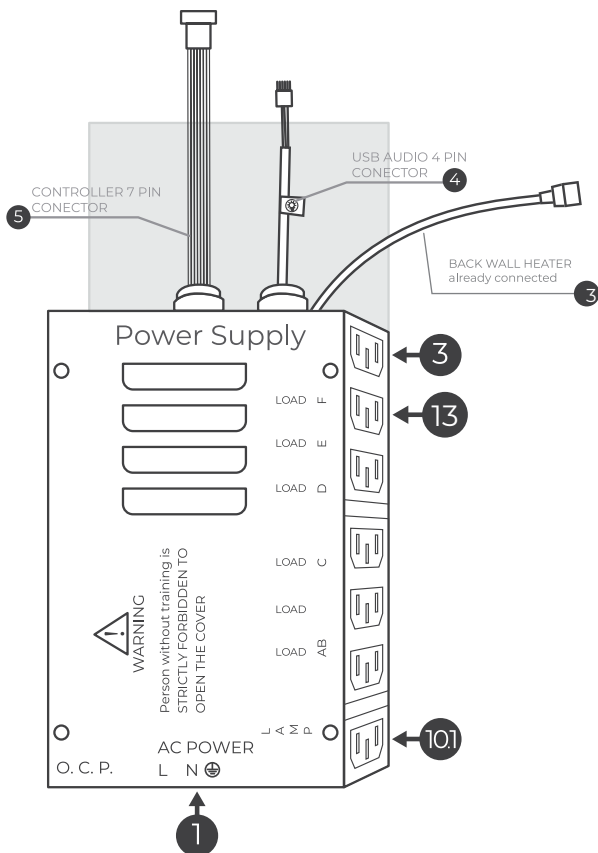
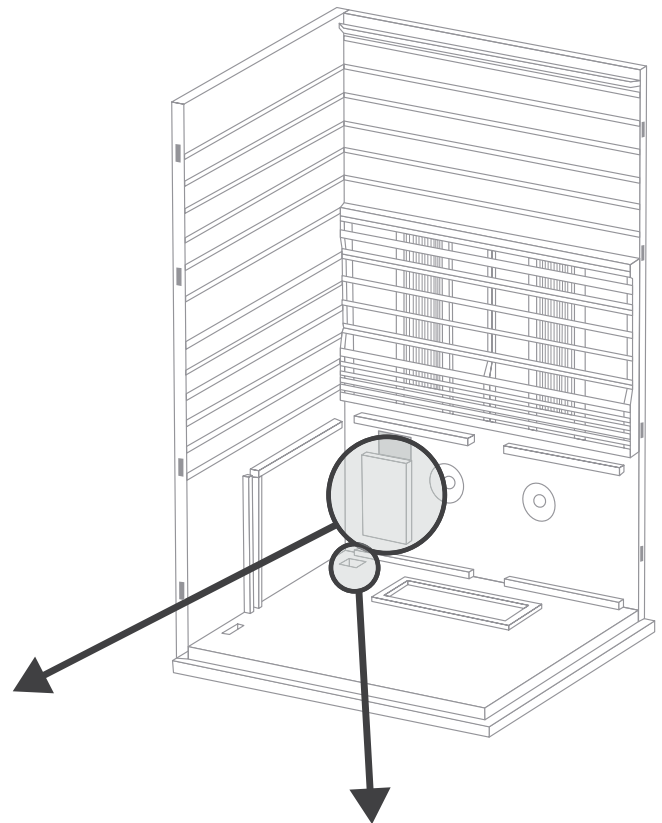



#### 4. INSTALL THE 4TH WALL

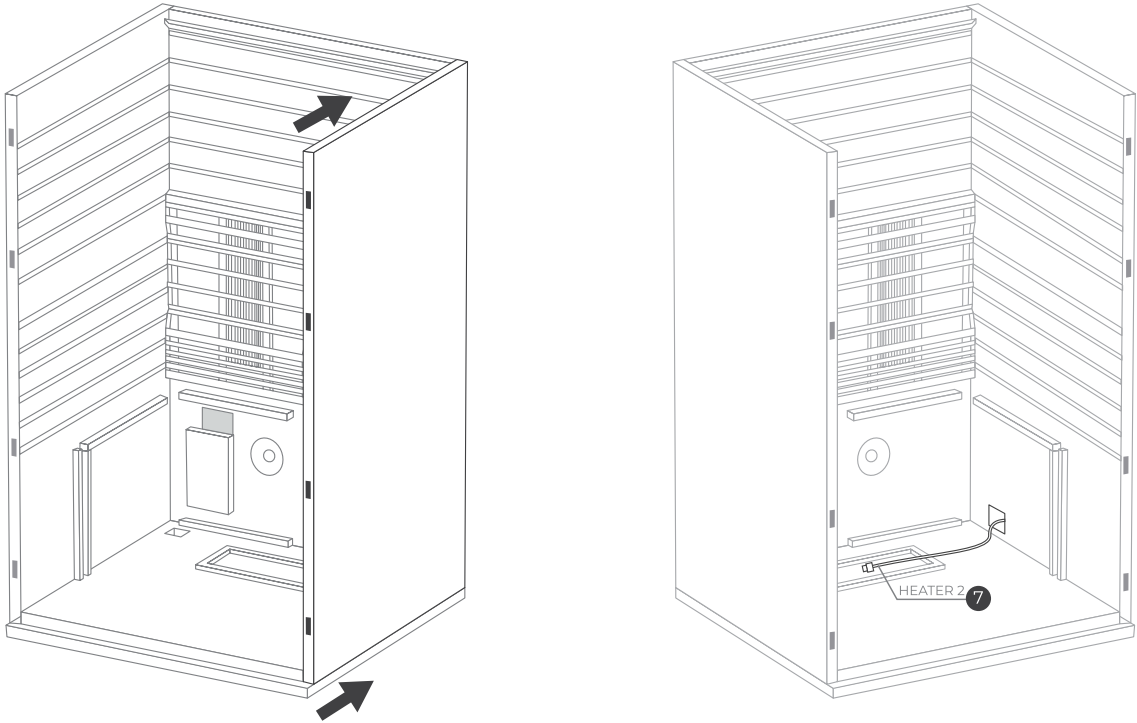

#### 5. INSTALL THE FRONT PANEL OF THE BENCH

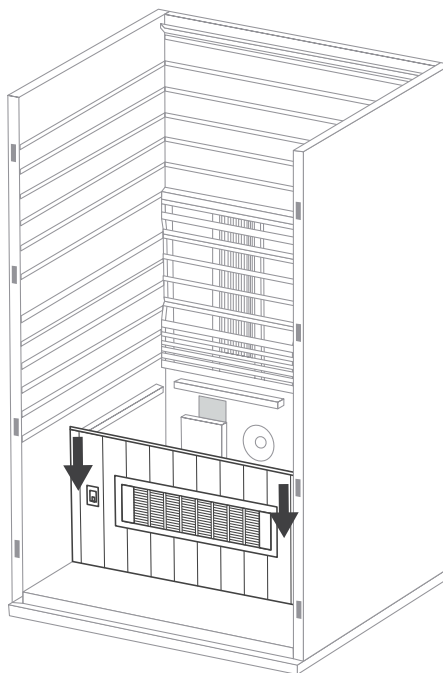



## 6. INSIDE THE BENCH WIRING

- Connect the floor heater power plug (marked **2** on the picture) to the bench support.
- Connect the cable labeled “Heater 2” (marked **7** on the picture) to the power supply.
- Connect the bench heater plug (marked **8** on the picture) to the power supply.

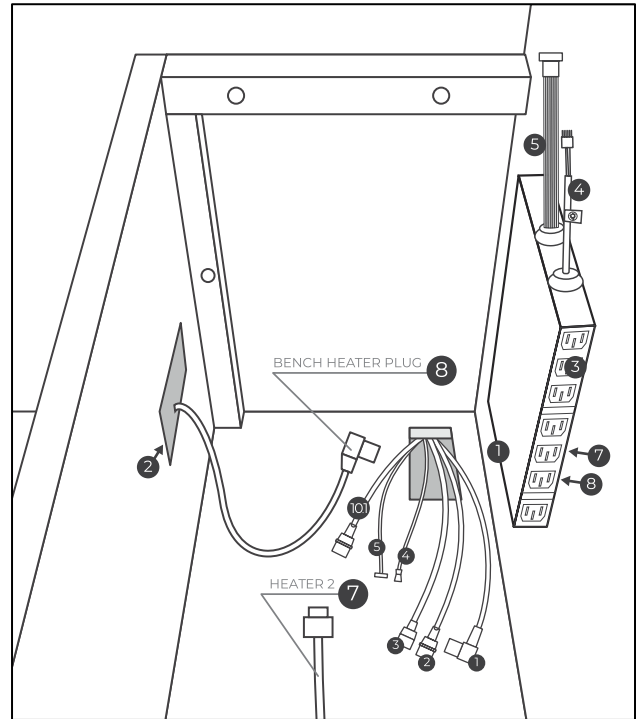

## 7. INSTALL THE TOP PANEL OF THE BENCH

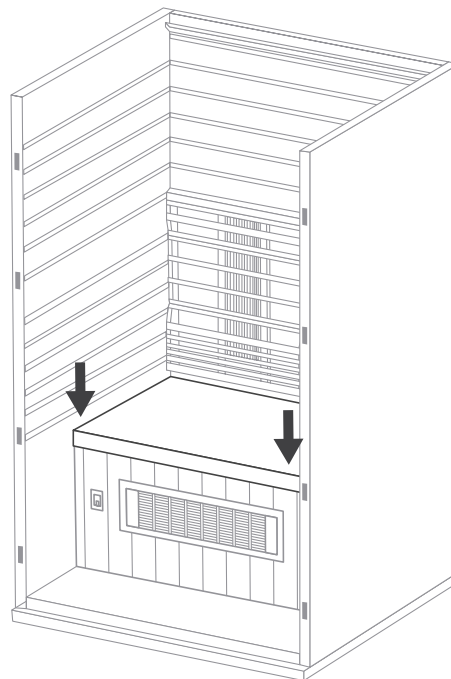



## 8. FRONT PANEL WIRING

- a. Connect the floor wires with the front panel wires (marked 9, 10, and 11 accordingly).

Floor wires

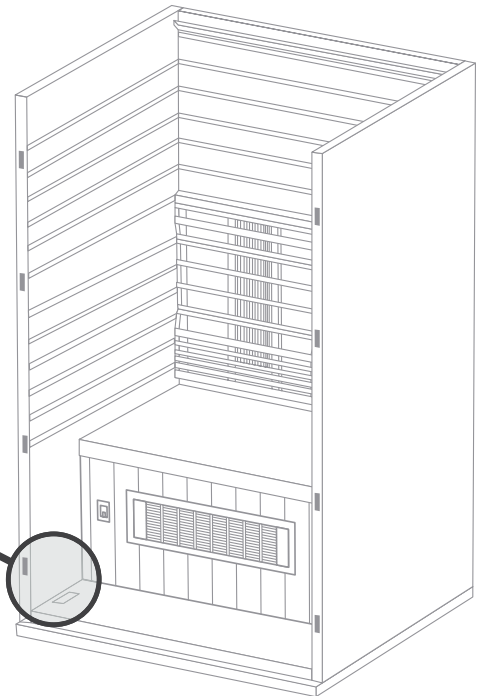
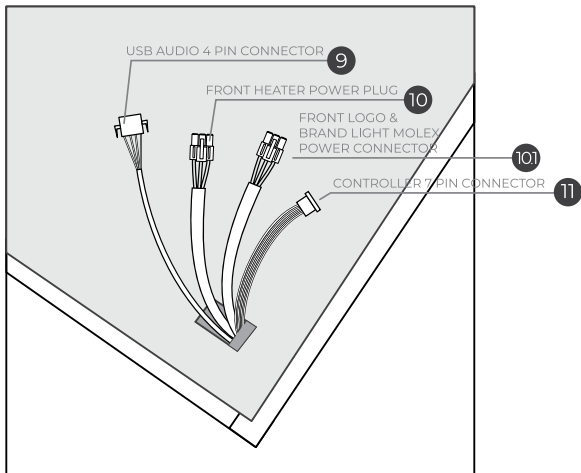

Front panel wires

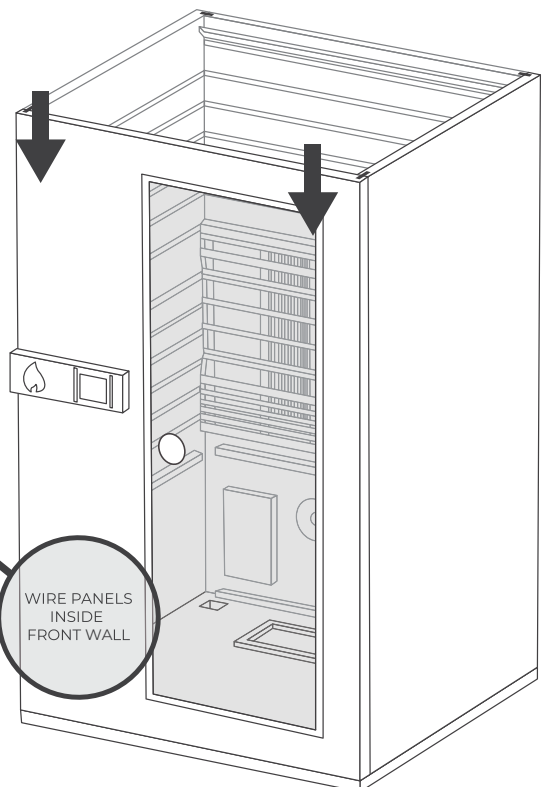
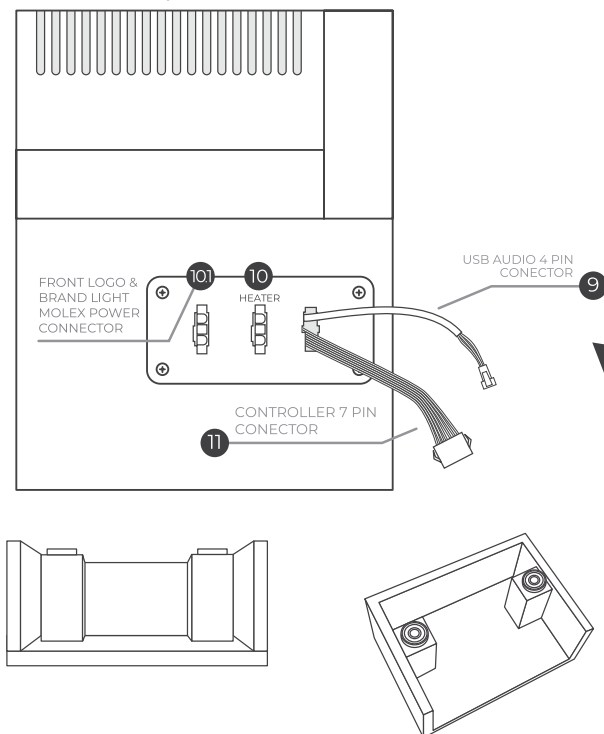



## 9. TOP PANEL INSTALLATION & WIRING

Connect the wires of the top panel with the wires on the top of the side panels according to the numbers.

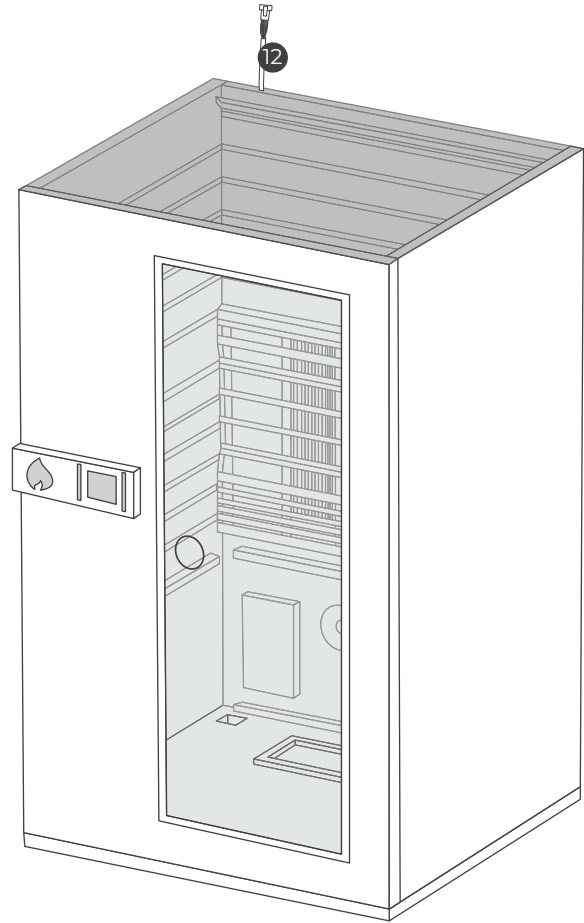
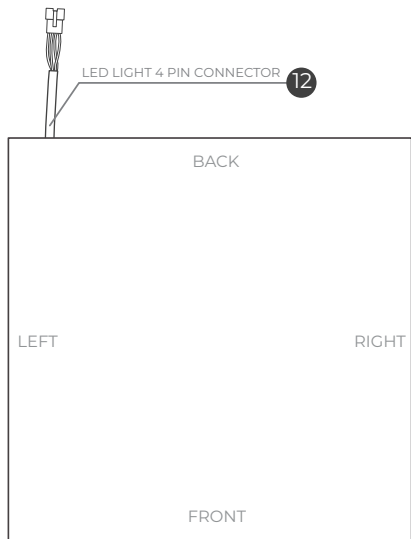



## 10. TOP PANEL INSTALLATION & WIRING

Insert the panel locking bracket (U-type).

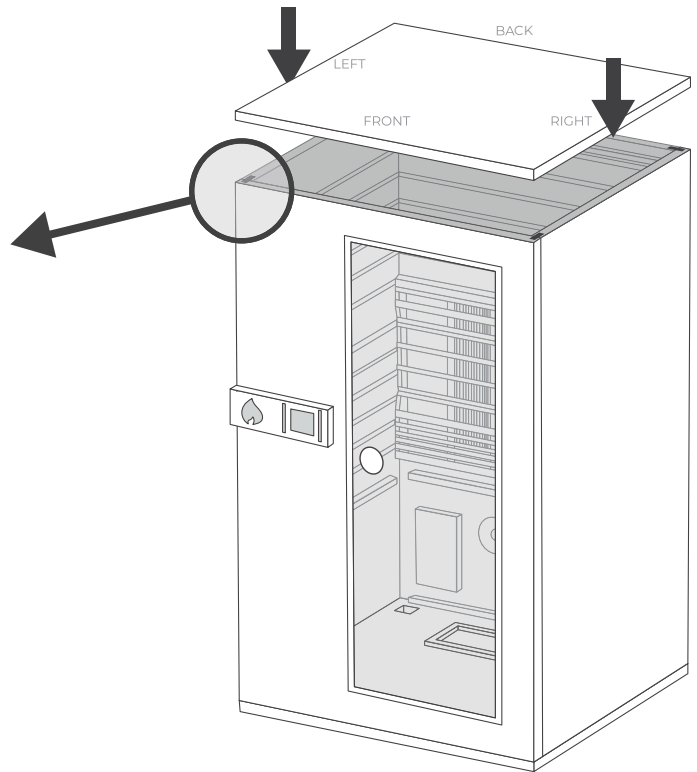
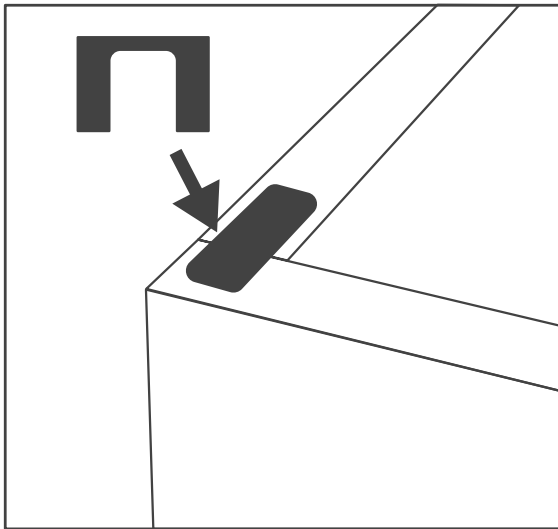

## 11. INSTAL THE HANDLE

Attach the door handle to the door by threading the bolt through the hole in the front of the door. Twist until snug.

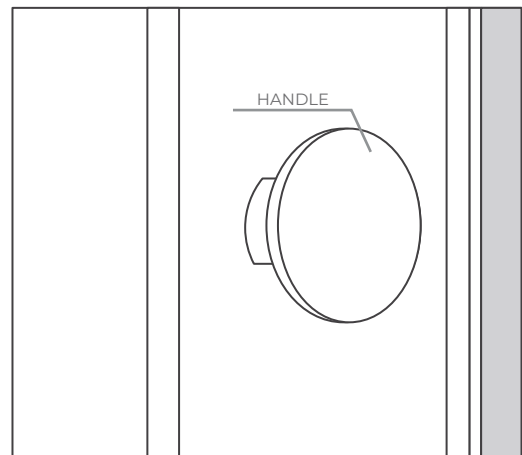



# CONTROL PANEL

## Control panel



**POWER BUTTON.** On and Off: when the system is powered on, press the power key, the actual temperature in the room will be displayed on the screen, and the back light of the keys will light green for IDLE.



**HEATING FUNCTION.** Press the HEALTH MATE LOGO key, to turn on or off the sauna heating. Once turned on, it will light RED. Once it is in IDLE or heating off it will display GREEN. NOTE\*: When sauna heaters are on, the button of the key is red, and when it is off, the key is green.



### TEMPERATURE SETTING.

Turn on the sauna heaters, and press the Mode key, the temperature indicator light will be on, press the Down key and the Up key to adjust the temperature of the sauna. The temperature adjustment range is 30-75 C, and the Fahrenheit degree is 90-170F. Note: when the temperature is adjusted, the temp indicator is on. When the temperature is not adjusted after 8 seconds, the temperature indicator is off and the actual temperature is displayed on the screen. LO when the ambient temperature is lower than the minimum temperature. (90F or 30C)



To change to Fahrenheit or Celsius: press the **MODE** key at the long time, wait for the ring. When the sound rings, you can switch between Fahrenheit and Celsius



**TIME SETTING.** Press the Mode key. Press until the time indicator is on, Once displayed. Press the Down key and the Up key to adjust the working time of the heating. The maximum working time is 60 minutes. When adjusting the time, the time indicator light at the screen is on, there is no operation time button for 8 seconds, the time indicator light is off, and the screen restores the temperature display.



# CONTROL PANEL

## Control panel



### CHROMOTHERAPY

Press the chromotherapy light as displayed above to control the chromotherapy. Press and hold the key for 3 seconds to enter the color changing mode. The screen shows "LX"

The back light of the key is RED when on, and the key is GREEN when it is turned off/idle.

In the color changing mode, short press the "chromotherapy" key to change the color of LED light, press to change one color at a time, you can cycle through till you reach desired light.

Please remember L1 = white, L2 = magenta, L3 = blue, L4 = cyan, L5 = green, L6 = yellow, L7 = red, L8 = sequence and L9 = gradient

If you do not press the "color light" key within 8 seconds, the window exits LX. The color of the LED light remains the current state and exits the light control logic lock function.

You can adjust brightness of diodes.

When the color lamp is in the color change mode (that is, the screen displays LX), press and hold the color lamp key for a long time to adjust the brightness of the lamp b1-b8. There is no key operation within 8 seconds, and the actual temperature is displayed on the screen



### LIGHTS

Press the Lamp key as picture displayed above to control the light of exterior and interior lights.

The backlight of the key is red when on, and the key is green when it is off/idle.



### BLUETOOTH

Click the BT key, the backlight of the key will change to Red when in use and the screen displays BT.

Turn on the Bluetooth function, and take the mobile device, search for Bluetooth "BT-sauna" and pair it.

Control Volume and song selection through mobile device.



## GETTING STARTED

### Preparing for your first infrared sauna home experience

1. Review all health and safety instructions. If in doubt as to the advisability of using your infrared sauna, consult with your physician
2. The interior & exterior of the Health Mate Infrared Sauna is made of the finest mahogany wood.

It is very aromatic and adds to the enjoyment of your sauna session. If the fragrance of the fresh wood is too strong during the first few months of usage, first wipe the wood with a damp cloth to minimize the aroma.

### Digital control panel

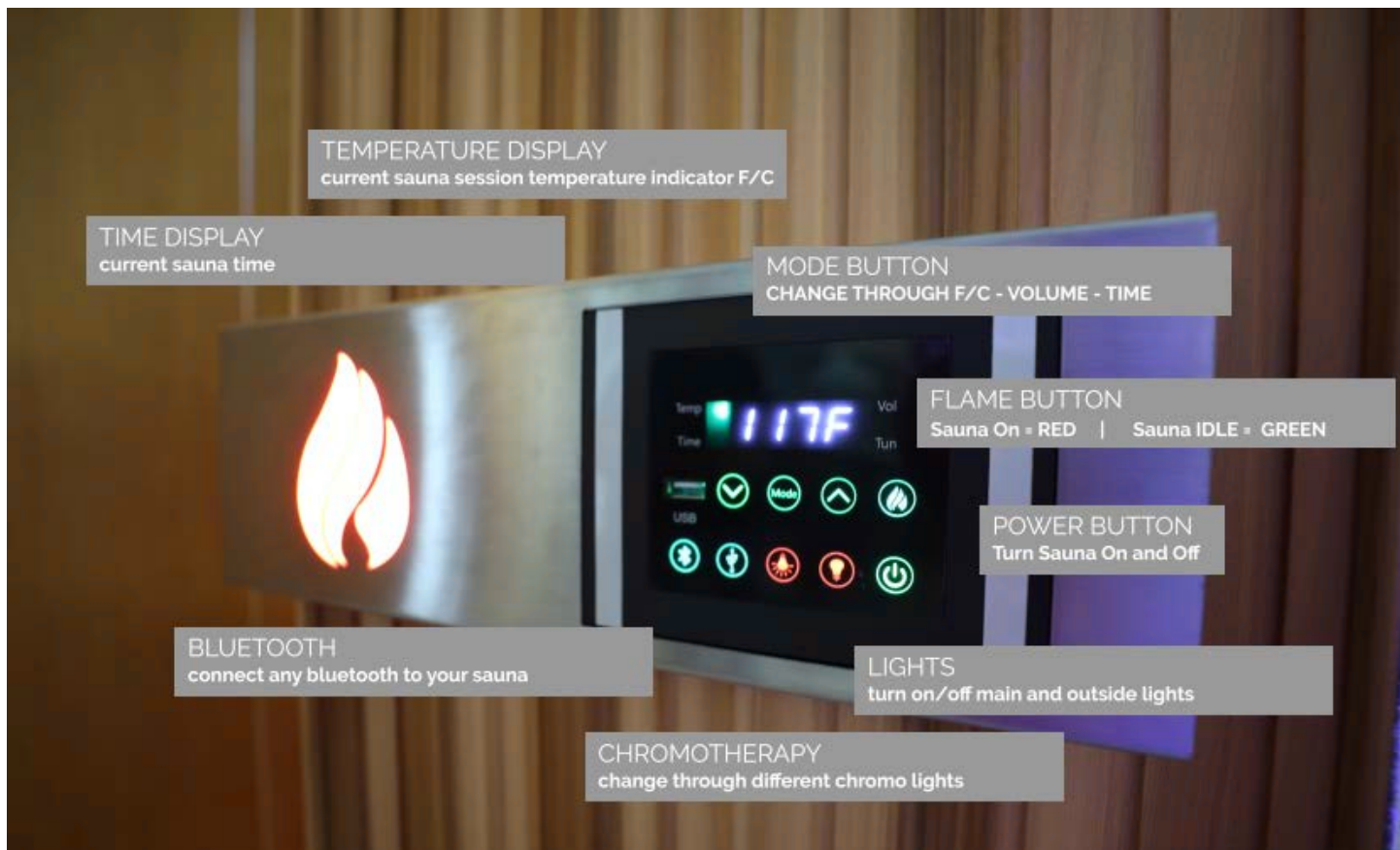



## GETTING STARTED WITH THE APP - ANDROID

### Powering up

- **MAKE SURE YOU ARE CONNECTED TO A 2.4 GHz NETWORK**
- Make sure to turn on the Bluetooth and the location features on the phone
- Download the app by searching for “Health Mate Sauna”

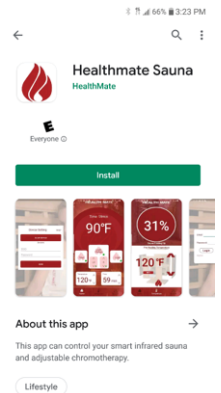

### Install and open app

- **REGISTER** by entering an email address and creating a password, please follow **app for additional instructions.**
- Enter the verification code sent via email to complete login set up.
- On the sauna controller touch the power button for 10 seconds until 2 beeps then activate the SCAN DEVICE on the app.
- CONNECT to the device to ESP32 or similar on app.
- When connected enter the Wifi ID : SSID and the password. Press enter or send.
- After the confirmation the device will automatically take you to the home tab.
- Allow a moment for the app to receive the information from the sauna and display the temperature

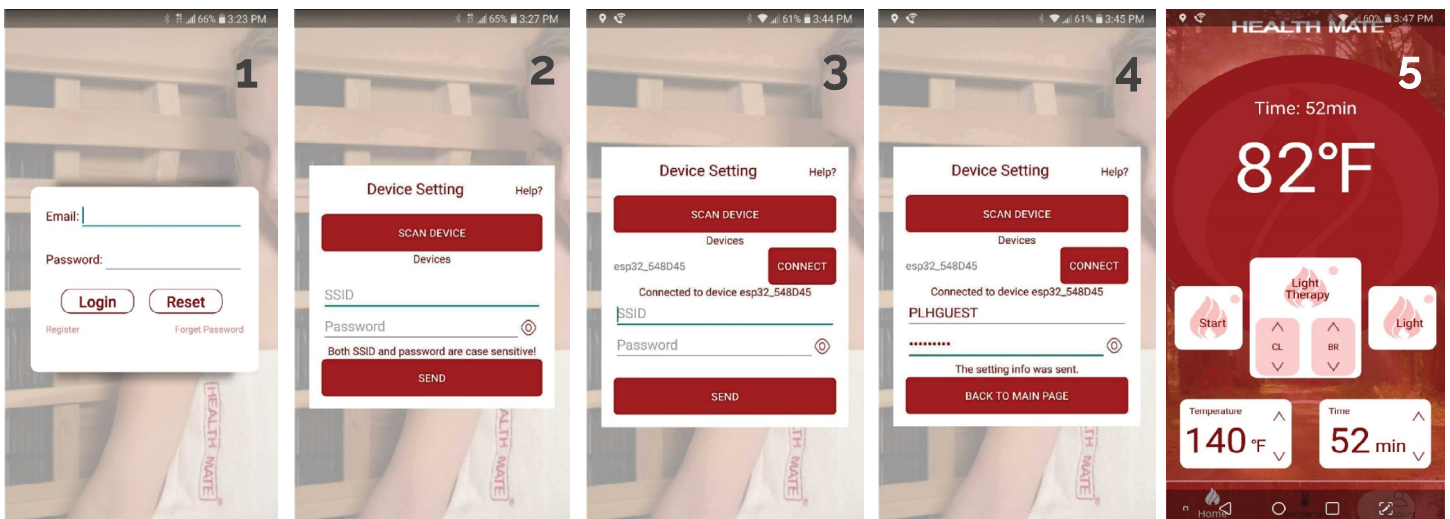



## GETTING STARTED WITH THE APP - ANDROID

### Start the heaters to warm up the sauna

- A green dot will light up on the app and the sauna controller will light up the logo button in red and the rest of the buttons in green.
- Adjust the temperature and the time. The heaters will go off after the set time lapses.



### Turn the light therapy on

Select the chromotherapy and the brightness

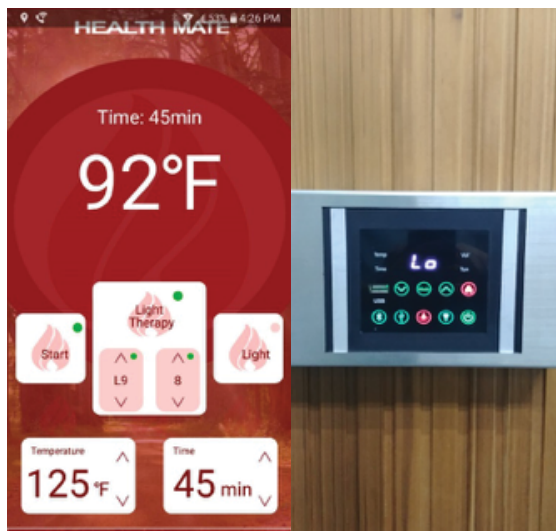

### Turn the lights on

Interior and exterior lights





## GETTING STARTED WITH THE APP - ANDROID

### Temperature tab will indicate how much progress on heating time

You can adjust and SET the temperature to change the desired temperature and the app will update the status after a moment.

After the sauna has reached the desired temperature it will display 100%. Please enjoy sauna!

### OTHER:

To turn any feature off, on the HOME tab touch the button on the app and the app will respond by putting the green dot out and the sauna controller will respond by turning the control panel button green.

\*The app response time can take a fraction of a second or few seconds depending on the Wifi traffic and the local internet connection.

To exit from the app, on the HOME tab touch the back button. When you re-open the app it will log in automatically and connect to the sauna.

To log out, on the ACCOUNT tab go to LOG OUT. When you re-open the app you will have to set up the connection to the sauna once again.

To turn the sauna controller off touch the power button to display off.

The app works on a mobile network, and you are able to start sauna anywhere.

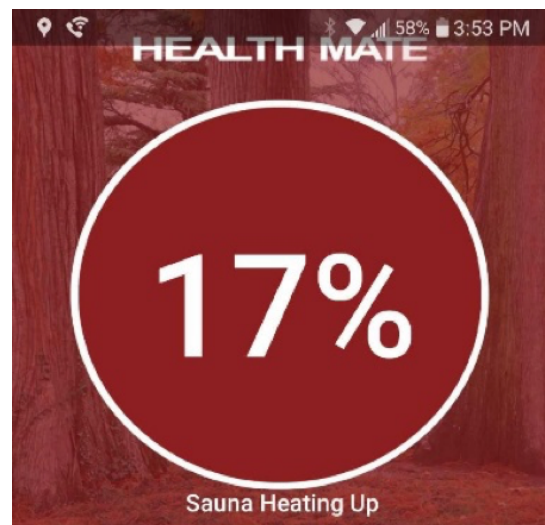

Pre-Heating Temperature





## GETTING STARTED WITH THE APP - IOS

### Powering up

- **MAKE SURE YOU ARE CONNECTED TO A 2.4 GHZ NETWORK**
- Make sure to turn on the Bluetooth and the location features on the phone
- Download the app by searching for “Health Mate Sauna”

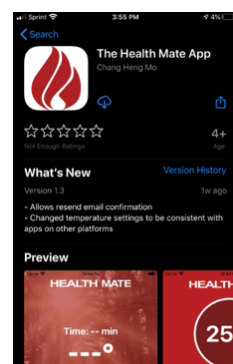

### Install and open app

- **REGISTER by entering an email address and creating a password, please follow app for additional instructions.**
- Enter the verification code sent via email to complete login set up.
- On the sauna controller touch the power button for 10 seconds until 2 beeps then RECONNECT the SCAN DEVICE on the app.
- Touch on the device to code ESP32 shown on app.
- When connected enter the Wifi ID or SSID and the password. Press SET UP.
- After the confirmation the device will automatically take you to the HOME tab.
- Allow a moment for the app to receive the information from the sauna and display the temperature.

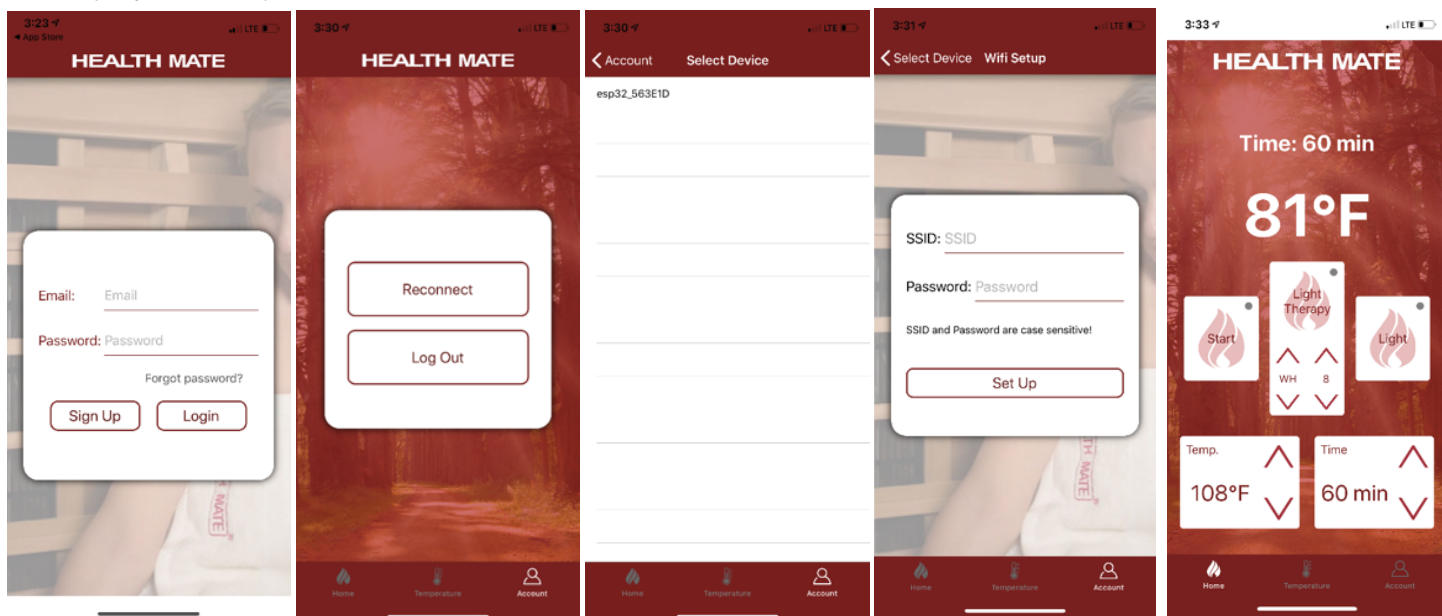
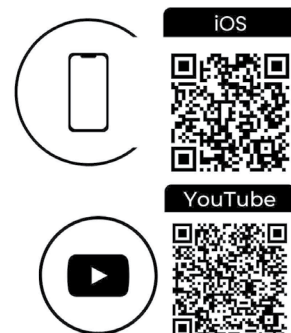



## GETTING STARTED WITH THE APP - IOS

### Start the heaters to warm up the sauna

- A green dot will light up on the app and the sauna controller will light up the logo button in red and the rest of the buttons in green.
- Adjust the temperature and the time. The heaters will go off after the set time lapses.

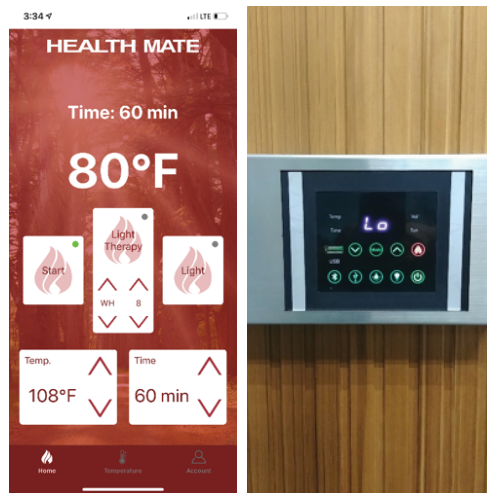

### Turn the light therapy on

Select the chromotherapy and the brightness

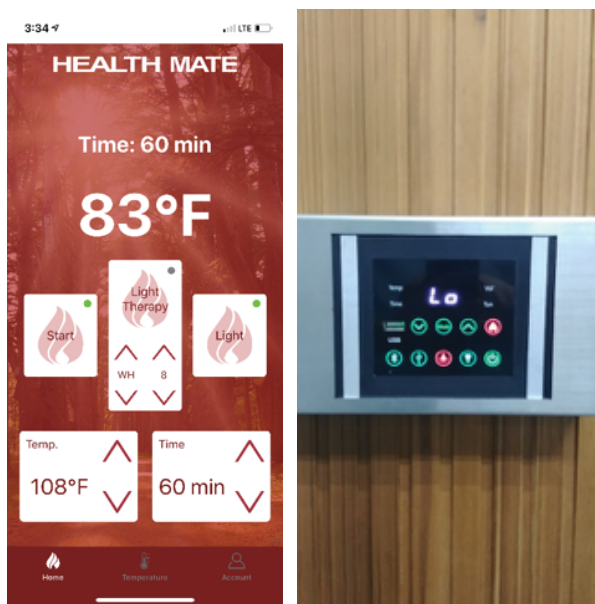

### Turn the lights on

Interior and exterior lights

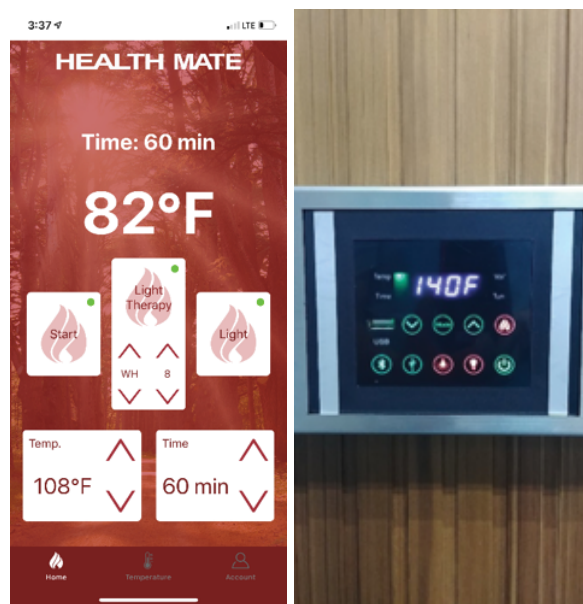



## GETTING STARTED WITH THE APP - IOS

### Temperature tab will indicate how much progress on heating time

You can adjust and SET the temperature to change the desired temperature and the app will update the status after a moment.

After the sauna has reached the desired temperature it will display 100%. Please enjoy sauna!

### OTHER:

To turn any feature off, on the HOME tab touch the button on the app and the app will respond by putting the green dot out and the sauna controller will respond by turning the control panel button green.

\*The app response time can take a fraction of a second or few seconds depending on the Wifi traffic and the local internet connection.

To exit from the app, on the HOME tab touch the back button. When you re-open the app it will log in automatically and connect to the sauna.

To log out, on the ACCOUNT tab go to LOG OUT. When you re-open the app you will have to set up the connection to the sauna once again.

To turn the sauna controller off touch the power button to display off.

The app works on a mobile network, and you are able to start sauna anywhere.

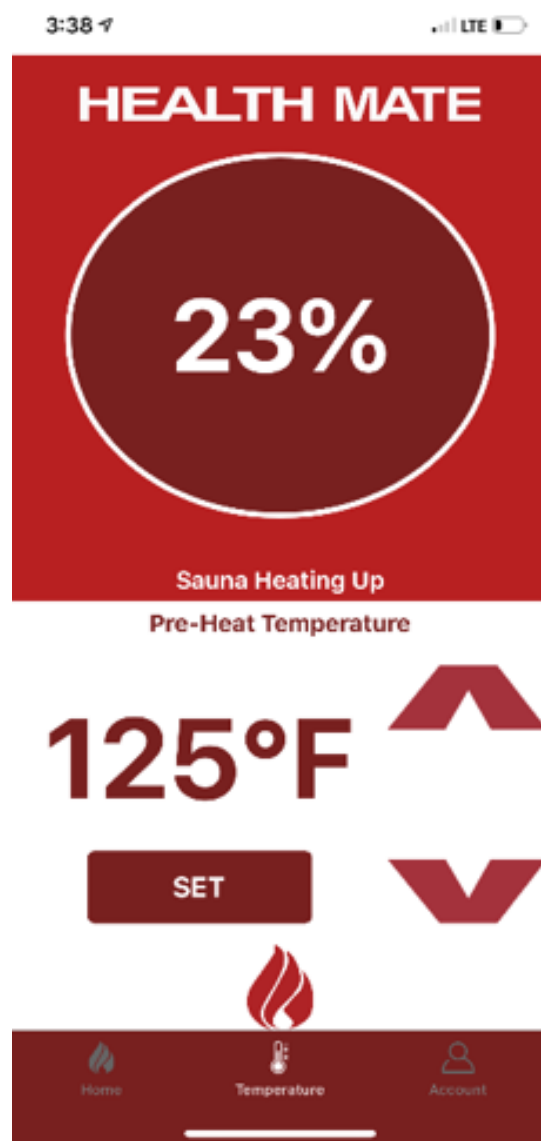



# HELPFUL TIPS FOR ENJOYING YOUR SAUNA SESSIONS

Your Health Mate Infrared Sauna is equipped with special infrared heaters. Infrared heat waves reach the body directly without having to heat the intervening air inside the sauna.

With this system, breathing is more comfortable and the atmosphere inside the sauna is more enjoyable than in conventional saunas. Because the infrared heat energy is warming the body directly (and not the air, walls, and fixtures within the sauna), lower temperature settings can be used to achieve results in short sessions starting from 20 to 30 minutes.

## 1) Preparing for your infrared session

- 1. Review all health and safety instructions.** If in doubt as to the advisability of using your infrared sauna, consult with your physician.
- The interior of the Health Mate Infrared Sauna is made of the finest Mahogany. It is very aromatic and adds to the enjoyment of your sauna session. If the fragrance of the fresh wood is too strong during the first few months of use, first wipe the wood with a damp cloth to minimize the aroma.
- Always **drink plenty of water**, before, during and after a session. Doing so will replenish fluids lost during perspiration.
- Do not eat anything at least an hour before your sauna session. It is better to **go in the sauna on an empty stomach**. You are more likely to feel uncomfortable sitting in a sauna with a full stomach.
- 5. Choosing to take a hot shower or bath prior to the sauna session will further promote perspiration.** However, dry off thoroughly before going into the sauna because excessive water will leave stains and might warp the wood.
- 6. Provide at least 2-3 towels.** One towel folded over several times for added cushioning on the bench. Another towel on the floor to absorb extra sweat. And a third towel to wipe off sweat.
- 7. Start up your sauna and select the desired session temperature and time** using the control panel (see page 6 and next page).
- 8. Allow approximately 15 to 20 minutes for the sauna to warm up** to a comfortable temperature before beginning a session (warm up time is subject to the air temperature and is different for each model)

**Please Note:** Your sauna's maximum temperature setting may not be achieved based on variations in ambient room temperature, air flow, placement of sauna, etc. If you are experiencing unusual warm-up times or if you have recently moved your sauna from one location to another, please call our technical support team for thermostat calibration help.



# HELPFUL TIPS FOR ENJOYING YOUR SAUNA SESSIONS

## 2) Setting session time and temperature

Your body will probably need a few weeks to fully adapt to a regular use of your Health Mate sauna.

Here are some average guidelines to set the time and temperature, once you are used to the sessions

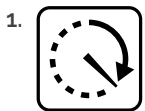

**Time:**

Noticeable results are usually obtained with sessions of at least 30 minutes. For therapeutic use, sessions of 45 minutes or more is advised.

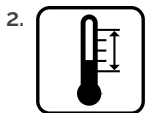

**Temperature:**

Depending on your condition and personal preferences, session temperature is usually set between 120°F/50°C and 140°F/60°C. If perspiration does not start after 10 to 15 minutes, this usually indicates that the temperature is set too low to obtain good results.

Always make sure you feel comfortable at all times!

**When using your Health Mate sauna for the first time:**

- **Do not do more than three sessions a week during the first four weeks.** You can do daily sessions after six weeks, if desired.
- **If you do not feel comfortable or relaxed during a session, lower the temperature and/or open the door of the cabin.**
- **Recommended schedule and settings for starters:**

	TIME	TEMPERATURE
week 1	20 min	120°F/50°C
week 2	23 min	120°F/51°C
week 3	26 min	125°F/52°C
week 4	29 min	125°F/53°C
week 5	32 min	130°F/54°C
week 6	35 min	135°F/55°C



# HELPFUL TIPS FOR ENJOYING YOUR SAUNA SESSIONS

## 3) Useful information and tips for during your sauna session

1. **Make sure you have a towel on the floor and on the bench of the sauna to absorb perspiration.** In order to maintain a clean and pleasant atmosphere inside of your sauna, do not leave damp towels on the bench or floor. Remove them immediately after the session is over.
2. Be sure to **towel off excess** sweat during your session to help the body perspire more freely.
3. When the temperature reaches the level set on the control panel, the heaters will turn off and on periodically in order to maintain the desired temperature level inside of the sauna.
4. The **ceiling vent on the top panel can be opened** at any time **to introduce fresh air** into the sauna.
5. If you **feel the need for more cooling, simply leave the door open** until the air around you feels comfortable enough.
6. **Do not put any lotions or oils on the body or face** prior to using the sauna. This may block the pores and hinder perspiration.
7. **Essential oils** can help you to find more tranquility during your session. You can use our ceramic aromatherapy cup (optional accessory) to evaporate your favorite oils.
8. **To make the most out of your sauna session, work your muscles while in the sauna.** Stretch your arms, legs etc. to help relieve sore and tense muscles and massage the affected areas while in the sauna. If you wish to achieve a deep heating effect to a specific area, move it closer to a heater.
9. **Relieve your ankles and feet more effectively, you must elevate them while inside the sauna.**
10. **Shaving your face or legs** with a razor while profusely sweating in a sauna yields an incredibly smooth result without the use of gels or foams.
11. Do not forget to **drink plenty of water**, before, during and after sessions to replenish lost fluids through perspiration.
12. After the session is over, **do not immediately jump into the shower.** Since your body was heated up during the session, it will continue to sweat even after the heaters are off. **Sit in the sauna with the door open and let your body cool off.** Once you feel comfortable enough, take a warm (or cool) shower to rinse the perspiration off your body.





# SAFETY PRECAUTIONS

## 1) General safety precautions

### 1. Read Instructions

Carefully read all safety and operating instructions before operating your sauna.

2. Retain these safety and operating instructions for future reference.
3. Do not smoke or light any fire inside your sauna.
4. To reduce the risk of injury, do not allow small children to use the sauna unless they are closely supervised at all times.
5. Do not use the sauna immediately after hard exercise. Wait at least 30 minutes to allow your body to cool down completely.
6. Exercise care when entering or leaving the sauna.
7. Never sleep inside the sauna while the unit is in full operation.
8. Unplug the sauna from the wall outlet before cleaning. Use a damp cloth for cleaning. Do not use liquid cleaners or aerosol cleansers inside the sauna.
9. Do not use this product near water, for example near a bathtub, in a wet basement or near a swimming pool.
10. Do not use attachments that are not recommended by the manufacturer, as they may cause a hazard.
11. The sauna must be placed under an awning or overhang to prevent heavy rain falling directly onto the roof or outdoor cover.
12. Do not stack or store any objects on top of or inside the sauna.
13. Use precaution when using electronic devices.
14. Do not install aftermarket devices.

## 2) Medical and health related precautions

1. If you intend to use far infrared therapy for medical reasons, please consult your physician prior to using the sauna.
2. Excessive temperatures have a high potential for causing fetal damage during the early months of pregnancy. Pregnant or possibly pregnant women should consult their physician prior to using the sauna.
3. The use of alcohol, drugs, or medications prior to or during the sauna session may lead to unconsciousness.
4. Persons suffering from obesity or with a medical history of heart disease, low or high blood pressure, circulatory system problems, or diabetes should consult a physician prior to using the sauna.
5. Persons using medications should consult a physician before using the sauna since some medications may induce drowsiness while others may affect heart rate, blood pressure, and circulation.
6. At the first sign of a cold or flu, increasing your sauna sessions may be beneficial in boosting your immune system and decreasing the reproductive rate of the viruses. Consult your physician for the proper treatment and care for this, before you start using your sauna.
7. **Hyperthermia Danger**  
Prolonged exposure to hot air will induce hyperthermia. Hyperthermia occurs when the internal temperature of the body reaches a level several degrees above the normal body temperature of 98.6°F/37°C. While hyperthermia has many health benefits, it is important not to allow your body's core temperature to rise above 103°F/39.4°C. Symptoms of excessive hyperthermia include dizziness, lethargy, drowsiness, and fainting. The effects of excessive hyperthermia may include failure to perceive heat, failure to recognize the need to exit, unawareness of impending hazard, fetal damage in pregnant women, physical inability to exit the sauna, and unconsciousness.



# SAFETY PRECAUTIONS

## 3) Power supply related precautions

1. **Dry your hands before handling electrical controls.** Never unplug the power cord or adjust the controls with wet hands or when you have wet bare feet. A danger of electrical shock exists.
2. **Your sauna is intended for use with a 3-wire properly grounded power socket.** Do not defeat the safety purpose of the supplied line cord and plug.
3. **This product should be operated only from the type of power source indicated on the marking label.** If you are not sure of the type of power supplied to your home, consult your local power company or electrician.
4. Power supply cords should be routed so they are not likely to be walked on or pinched by items placed upon or against them.
5. **For added protection during a thunder storm,** or when it is left unattended and unused for long periods of time, unplug it from the wall outlet.
6. **Do not overload wall outlets and extension cords** as this can result in a risk of fire or electrical shock.
7. **Always unplug this product from the wall outlet before servicing the product.**
8. **Do not remove power supply covers.** No user-serviceable parts are located inside the power supply.
9. **We strongly recommend the use of a GROUND FAULT CIRCUIT INTERRUPTER (GFCI)** device in any potentially wet locations.

## 4) Warranty precautions

1. **When replacement parts are required, be sure to use replacement parts specified by the manufacturer** or have the same characteristics as the original parts. Unauthorized substitutes may result in fire, electrical shock or other hazards and will void the manufacturer's warranty.
2. If the power supply cord becomes damaged, it must immediately be replaced by the manufacturer or its agent or similarly qualified person to avoid hazard.
3. **Altering or tampering of any electrical connections** on the power supply will void the manufacturer's warranty.
4. **Do not attempt any repair without consulting the manufacturer first.** Unauthorized repair attempts will void manufacturer's warranty.
5. Your Health Mate sauna is made of the finest Mahogany. **All natural wood products have variations in the color, the grain, and irregularities such as knots, and fine cracks. These characteristics are a part of the natural beauty of the wood, and in no way should be considered defective.**
6. Upon completion of any service or repairs to this product by a service technician, ask the service technician to perform safety checks to determine that the product is in proper operating condition.



# TROUBLESHOOTING GUIDE

QUESTION	ANSWER
<b>Control panel is beeping and showing an error message.</b>	<ul style="list-style-type: none"><li>• The temperature sensor inside your control panel housing has been disconnected. Remove control panel (video available) and confirm the two pin connection is securely fastened</li></ul>
<b>There is no heat coming from my front heaters.</b>	<ul style="list-style-type: none"><li>• First thing you want to do is check the blue Molex connection inside the sauna. It's located on the bottom right of the sauna if you're sitting on the bench. You want to make sure that it is plugged in correctly. You will notice that the 2 outermost prongs on the connection have a rounded edge, while the center prong is a complete square. Be sure to match these plug shapes to the inlet for a proper connection.</li><li>• Check heater power cable connections</li></ul>
<b>All other Sound System problems:</b>	<ul style="list-style-type: none"><li>• Unplug the sauna, wait 10 minutes, then plug back in.</li></ul>
<b>What are the electrical requirements for my new sauna?</b>	<ul style="list-style-type: none"><li>• Serenity 2 : 120V 15 Amp</li><li>• Serenity 3 : 120V, 20 Amp</li></ul>
<b>My new sauna is completely dead.</b>	<ul style="list-style-type: none"><li>• Make sure the power cord is plugged into the sauna power supply and the other end is plugged into the wall socket.</li><li>• Try pressing each of the 2 reset buttons on the sauna power supply.</li><li>• Unplug the sauna and plug something else, such as a lamp or radio, into the wall socket to verify there is power to that socket. If there is no power, check the house circuit breaker for that line.</li></ul>



# TROUBLESHOOTING GUIDE

QUESTION	ANSWER
<b>The controller display is faint or does not display correctly in some other way.</b>	<ul style="list-style-type: none"><li>• Try unplugging the sauna for about 5 minutes, then plug it back in. This should correct any display problems.</li></ul>
<b>The sound system works, but nothing lights up on the controller display. I unplugged the sauna for 5 minutes but it didn't help.</b>	<ul style="list-style-type: none"><li>• Check to see that the data cable is plugged in at both ends.</li></ul>
<b>The sound system doesn't turn on.</b>	<ul style="list-style-type: none"><li>• Check to make sure the speaker connectors at the power supply are correctly plugged in.</li></ul>



# TROUBLESHOOTING GUIDE

QUESTION	ANSWER
<b>Wrong A.C. Power cord (female end of power cord does not match the male end of cable on sauna)</b>	<ul style="list-style-type: none"><li>• The power cord and the cable in the sauna floor near the power box do not attach or connect to each other.</li></ul>
<b>House circuit breaker is tripping</b>	<ul style="list-style-type: none"><li>• Check that the amperage of the breaker corresponds with the amperage rating of your sauna. Make sure that the circuit is not overloaded by having too many appliances on one circuit. Please contact a local electrician.</li></ul>
<b>Look for a manufacturer's label next to the DATA and HEATER sockets at the bottom of the front panel</b>	<ul style="list-style-type: none"><li>• Look for a manufacturer's label next to the DATA and HEATER sockets at the bottom of the front panel.</li></ul>

Troubleshooting tips are also available at [healthmatesauna.com/troubleshooting](https://healthmatesauna.com/troubleshooting)

Please contact the manufacturer with any other questions regarding customer service or troubleshooting.



# OPTIONAL ACCESSORIES

## Aroma Mate

Adding just a few drops of essential oils to your Aroma Mate aromatherapy cup will transform your warm space to a calming place. Visit your health food store for non-diluted and non-alcoholic quality essential oils. This accessory does not require any assembly.



## Floor Mate

Dimensions (width x depth x height): Medium – 24" X 18" X 1.25" | Large – 36" X 18" X 1.25" The floor mat is designed to be put outside in front of your sauna door. This accessory does not need any assembly.

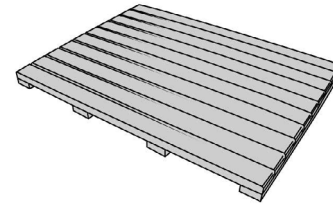

## Shelf Mate

This accessory can be easily assembled with a Phillips screwdriver. The shelf is simply attached on the outside of your sauna, with two metal hooks between the roof and wall top.

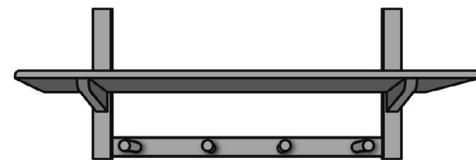



# LIMITED WARRANTY

Health Mate Sauna warrants the Health Mate Infrared Saunas to be free of defects in material and workmanship.

Health-Mate Sauna Cabin & Frame	10 years	1 year
Health-Mate Sauna Vertical Paneling	10 years	1 year
Health-Mate Sauna Flooring and Baseboard	10 years	1 year
Health-Mate Sauna Door/ Glass/ Hinges	10 years	1 year
Health-Mate Sauna Handles & Fixtures	10 years	1 year
Sauna Electronic Controls & Wiring	10 years	5 year
Heater Core, Harness, and Wiring	Lifetime	5 year
Interior Lighting Fixtures and Wiring	10 years	5 year
Exterior Lighting Fixtures and Components	10 years	5 year
Interior Audio Fixtures and Components	10 years	5 year
Labor of Factory Installed Components	10 years	5 year
Upgrades, Options, Parts & Accessories	Per Manufacturer's Warranty Unless Otherwise Noted at Sale or Contract	

Company warrants to the user during the warranty period that the Sauna Cabin will maintain its structural integrity. The factory installed components (i.e., heater controls, power supply, electrical wiring, and audio system) will be free from defects in material or workmanship. This limited warranty shall not apply to any display model unless expressly agreed by Health Mate in writing at the time of purchase or to any Sauna installed more than six months after the delivery date.

This warranty extends only to the original retail purchaser of the sauna and terminates upon transfer of ownership. It does not extend to

commercial or institutional use or installation.

Freight charges to and from the customer are the responsibility of the customer (flat fee). This includes freight charges for parts shipped to enable the services of your sauna.

This warranty is void if the sauna has been subjected to alteration, misuse, abuse, accident, natural disaster or non-factory authorized modification or repair. This warranty is also void if the sauna has been operated or maintained in deviation to the published instructions. The warranty extends only to the manufacturing defects and does not cover any damages resulting from mishandling of the



# LIMITED WARRANTY

product by the owner. This warranty does not cover any normal wear and tear due to usage. This warranty also does not cover any damages caused by natural weather conditions even when the sauna is covered with the factory authorized outside cover. Broken glass and light bulb, whatever the cause, are not covered by this warranty.

Health Mate Sauna shall not be liable for the loss of use of the sauna or other incidental or consequential damages. Under no circumstances shall Health Mate Sauna or any of its representatives be held liable for injury to any person or damages to and properties. Some states allow limitations on how long specified warranty lasts. Some states do not allow exclusion or limitation of incidental or consequential damages, so the above limitations or exclusions may not apply to you. This warranty gives you specific legal rights, and you may also have other rights that vary from state to state. Specifications are subject to change without notice state to state. Specifications are subject to change without notice.

The warranty period begins on the date the unit is purchased by the user. This warranty may not be transferred, sold, donated, gifted or assigned to a third party except with the prior written consent of Health Mate Sauna, in its sole and absolute discretion. Absent written consent, only the original purchaser can make claims hereunder. All warranty labor must be performed by Health Mate or its designated representative using authorized Health Mate parts. No agent, dealer, distributor, service company or other party is authorized to change, modify, or extend the terms of this limited warranty in any manner whatsoever. Any warranty so provided shall be solely their separate obligation. As used in this warranty, "commercial use" shall mean any

use that involves a fee, rate, charge, or other consideration, any use directly or indirectly in connection with a business, going concern, or undertaking intended for profit or pecuniary gain, and any non-residential use, "residential use" shall mean when purchased for use by a single-family for internal household purposes, and "user" shall mean the original purchaser.

The limited warranty does not cover defects, damage, or failure ("Damage") caused by the delivery service providers or common carrier, the installer, user, or other persons and animals, including without limitation, termites and other wood-destroying insects or rodents. The limited warranty excludes Damage resulting from transportation, careless handling, improper location, storage, or relocation, as well as from cleaning, painting, staining or other use of abrasive or improper chemicals. The limited warranty also excludes Damage arising from user's or a third party's negligence; modification of any type for any reason (including modification to meet local codes); improper installation (including installation not in accordance with instructions and specifications provided with the unit); connections supplied by the installer of the equipment, an electrician or a third party; improper voltage supply; unauthorized electrical modification; misuse; improper use; abuse; incorrect operation, lack of proper routine or preventive maintenance; unauthorized repair by a third-party; normal wear and tear; fire, and acts of God such as lightning, floods, earthquakes, etc. Outdoor-Use Sauna warranties do not include damage arising from a failure (i) to maintain the Sauna on a flat, level, hardtop surface with adequate drainage and (ii) to keep the exterior free and clear from plants, trees, grasses, soil, and snow deposits.



# LIMITED WARRANTY

**For your record, please complete the following information.**  
You will need to refer to this information when calling customer service:

**Date of Purchase** \_\_\_\_\_ **Date of Delivery** \_\_\_\_\_

**Model Number** \_\_\_\_\_ **Serial Number** \_\_\_\_\_

**Dealer Information** (Name & Telephone) \_\_\_\_\_

\_\_\_\_\_

\_\_\_\_\_

\_\_\_\_\_

**Where is the serial number on my new sauna?** Look for a manufacturer's label next to the DATA and HEATER sockets at the bottom of the front panel.

**Address:** 16511 Carmenita Road, Cerritos, CA 90703

**Fax #:** 714.739.6605

**Toll Free #:** 800.946.6001

**Email:** support@healthmatesauna.com

**healthmatesauna.com**



# HEALTH MATE

---

infrared wellness since 1979

---

**800 946-6001 | [HEALTHMATESAUNA.COM](https://www.healthmatesauna.com)**